

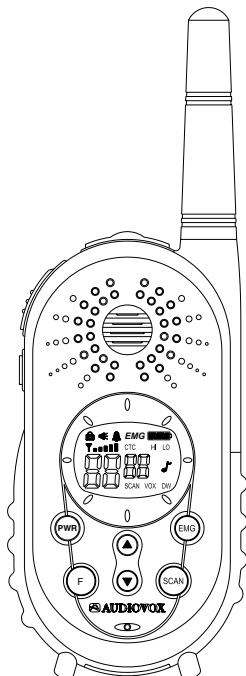

# General Mobile Radio Service (GMRS) Model: GMRS1100-2CH



## Owner's Manual



For Customer Service  
Visit Our Website At  
[www.audiovox.com](http://www.audiovox.com)  
Product Information, Photos,  
FAQ's, Owner's Manuals

© 2002 Audiovox Electronics Corp., Hauppauge, NY 11788

Customer Service  
1-800-290-6650

Released: 3-12-02.

Revision A: 7-25-02. Complete rework to accommodate new  
manufacturer changes.

**128-6297A**

**1 of 24**

 **CAUTION**

NEVER ATTEMPT TO CHARGE ALKALINE OR DRY CELL BATTERIES, AS BATTERIES MAY BURST CAUSING PERSONAL INJURY AND DAMAGE TO THE PRODUCT. WHEN RECHARGING NICKEL METAL HYDRIDE (Ni-MH) BATTERIES WITH THE SUPPLIED AUDIOVOX CHARGER AND WALL ADAPTER, USE ONLY AUDIOVOX-APPROVED RECHARGEABLE BATTERIES. USE OF THE AUDIOVOX CHARGER WITH OTHER BRANDS OF BATTERIES IS NOT RECOMMENDED, AS BATTERY CHARGING TIMES WILL VARY WITH DIFFERENT BRANDS. REFER TO THE MANUFACTURER'S INSTRUCTIONS FOR CHARGING OTHER BRANDS OF BATTERIES.

AVOID PLACING THE GMRS1100-2CH RADIO TRANSCEIVER FOR PROLONGED PERIODS OF TIME IN DIRECT SUNLIGHT OR TEMPERATURES BELOW -4° F (-20° C) OR ABOVE 140° F (60° C).

KEEP THE ANTENNA AT 1 INCH (2.5 cm) AWAY FROM YOUR HEAD AND BODY. DO NOT USE YOUR GMRS1100-2CH RADIO TRANSCEIVER WITH A DAMAGED ANTENNA.

PLACE THE RUBBER COVERS ON JACKS WHEN NOT IN USE.

**GMRS LICENSE:**

USE OF THIS RADIO WITHIN THE UNITED STATES REQUIRES AN FCC GMRS LICENSE. AN INDIVIDUAL 18 YEARS OF AGE OR OLDER, WHO IS NOT A REPRESENTATIVE OF A FOREIGN GOVERNMENT, IS ELIGIBLE TO APPLY FOR A GMRS SYSTEM LICENSE. YOU WILL NEED TWO FORMS FROM THE FCC; FCC FORM 159 AND FCC FORM 605 MAIN FORM AND SCHEDULE F. YOU CAN FIND THE FORMS ONLINE AT: [HTTP://WWW.FCC.GOV/FORMPAGE.HTML](http://www.fcc.gov/formpage.html), OR CALL 1-800-418-3676.

## Model GMRS1100-2CH (FCC License Required)

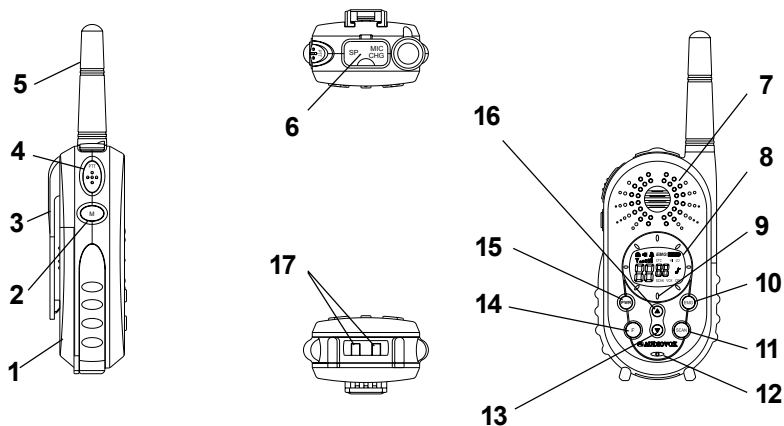

1. Battery Cover
2. Monitor/Function Confirmation Button
3. Detachable Carry Clip
4. Push-To-Talk (PTT) and Function Confirmation Button
5. Antenna
6. External Speaker (SPK), Microphone (MIC)/CHG Jacks
7. Built-in Speaker
8. Liquid Crystal Display (LCD)
9. Combination Transmit Indicator (Red)/Receive and Monitor Indicator (Green)
10. Emergency (EMG) Button
11. Channel SCAN Button
12. Built-in Microphone
13. Down Channel/Volume Button
14. Function (F) Button
15. Power (PWR) On/Off Button
16. Up Channel/Volume Button
17. Battery Charging Contacts

## Model GMRS 1100-2CH DISPLAY

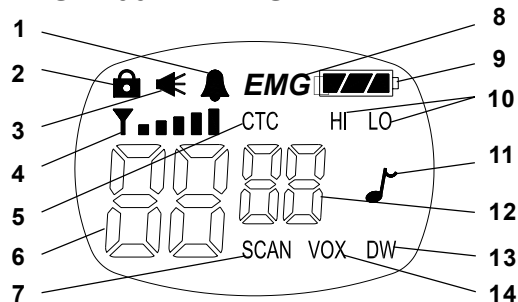

- 1. Beep Tone Indicator:** Icon appears when beep button confirmation tone is selected; icon disappears when tone is off.
- 2. Key Lock Indicator:** Icon appears when the keypad is locked. This function disables keys such as channel up/down and Function (F).
- 3. Monitor Indicator:** Icon appears when the Monitor (M) button is pressed and the channel monitor function is activated.
- 4. Signal Strength Indicator:** Icon appears when a signal is being received. The icon consists of five bars to indicate the received signal level. The icon also represents transmit signal power during transmission.
- 5. Coded Tone Controlled Squelch System (CTC) Indicator:** Icon appears when the CTCSS tone function is active.
- 6. Large Segment Display:** Indicates the channel number in use between 1 and 22.
- 7. Scan Indicator:** This function allows the user to scan a channel and/or a tone code every 0.5 second to search for a valid signal.
- 8. Emergency Indicator:** The EMG icon appears when the EMG button is pressed. (The frequency is **NOT** monitored by authorities.)
- 9. Battery Level Indicator:** Icon indicates the battery charge level.
- 10. HI/LO Indicators:** Appropriate icon appears when the transmit power is set to desired output power.

- 11. Roger Beep Tone Indicator:** This icon appears when the Roger Beep tone is on, and disappears when the tone is not in use.
- 12. Small Segment Display:** Indicates the CTCSS tone code (1-38) function is active for the main channel in use.
- 13. Dual Watch Mode Indicator:** Icon appears when dual watch mode is active.
- 14. Voice Activated Transmission (VOX) Indicator:** This icon appears when the VOX mode is activated.

### **Equipment and Accessories Supplied**

- |    |                            |                       |
|----|----------------------------|-----------------------|
| 1. | Radio (2)                  | GMRS1100-2CH          |
| 2. | Owner's Manual (1)         | 128-6297B             |
| 3. | Rechargeable Batteries (8) | NiMH, P/N SBGMRS11001 |
| 4. | Dual Desk-Top Charger      | DTC1100-2CH           |
| 5. | AC Wall Adapter            | UD-1201B              |

### **Powering the transceiver:**

Your GMRS1100-2CH radio transceiver operates on four AAA batteries. Alkaline batteries will provide slightly better performance than rechargeable batteries. Only the supplied Audiovox-approved rechargeable batteries can be recharged in the radio transceiver using the supplied desk-top charger and associated wall adapter. This will ensure optimum performance for the GMRS1100-2CH. Battery charging time is typically 10-12 hours. Use of the Audiovox charger with other brands of rechargeable batteries is not recommended as battery charging times will vary. Refer to the manufacturer's instructions for charging other brands of batteries.

### **Batteries**

There are three methods of powering the GMRS1100-2CH:

- 1. Alkaline Batteries.  
**WARNING:** Do not attempt to recharge Alkaline batteries.
- 2. Audiovox Rechargeable Ni-MH Batteries - (Rechargeable Ni-MH batteries, Wall Adapter and Charging Stand included).

Use only Audiovox-approved rechargeable batteries and charger when charging batteries internal to the unit.

**NOTE:** To extend battery life, avoid overcharging the batteries.

3. Various Brands of Rechargeable Batteries - Use of the Audiovox charger with other brands of rechargeable batteries is not recommended, as battery charging times will vary with different brands of batteries. Refer to the manufacturer's instructions for charging other brands of batteries.

### Installing the batteries:

Battery installation is made more convenient when the carry clip is removed. To do this, release the spring clip securing the belt clip to radio and slide the belt clip upward and away from the radio body. Next, press down with the thumb at the embossed arrow, slide the battery cover down and lift off the battery cover. Insert four AAA batteries (alternate positive ends (+) toward the top of the transceiver, starting left-to-right).

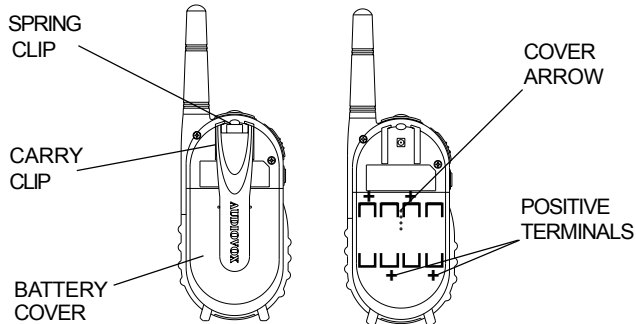

1. Using thumb, press down on battery cover at arrow and slide cover down to open.
2. Slide the cover down and then lift cover at bottom to open. Remove cover.
3. Insert four AAA batteries (positive (+) end toward the top beginning at left side and alternating positive terminals as shown).

The following guidelines will improve performance and provide longer operating times for the GMRS1100-2CH:

1. Do not mix old and new batteries.
2. The use of alkaline-type batteries is recommended to provide the longest operating time.
3. Do not mix alkaline, standard (carbon-zinc) or rechargeable batteries.
4. If the unit is not to be used for an extended period of time, remove the batteries. Old or leaking batteries can cause damage to the unit and will void the warranty.

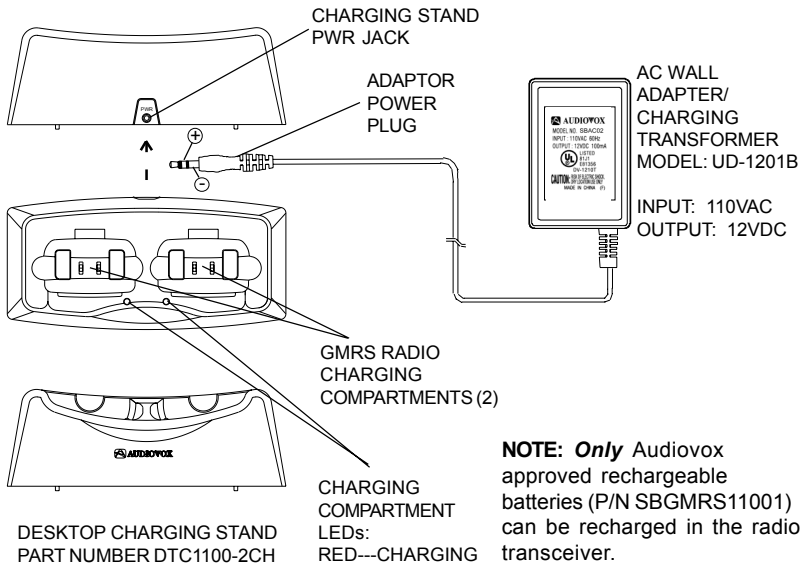

## GMRS1100-2CH OPERATIONAL MODES

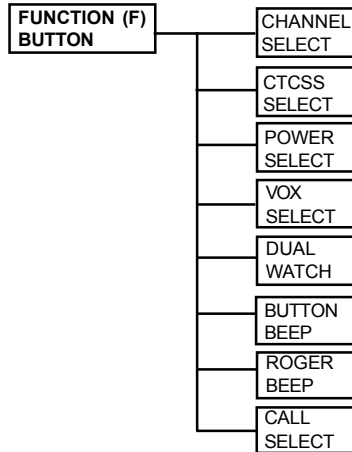

**NOTE:** To differentiate between operating modes, look for **HI** or **LO** indication below the battery power level indicator when in GMRS mode. Refer to the appropriate section of this manual for detailed operating instructions for each mode. When in standby mode, the transmit/receive indicator will flash once every 5 seconds, indicating the unit is in the power-save mode.

### Controls:

#### Power (PWR) On/Off (15) Button

Press and hold the PWR on/off button for at least 2 seconds. You will hear a confirming melody to indicate the unit is on. To turn the unit off, press and hold the button for at least 2 seconds.



#### Adjusting the Volume (16, 13)

With the unit powered on, press the Up Channel/Volume button (▲) to increase volume and the Down Channel/Volume button (▼) to decrease



volume. The display will indicate the current volume level (**UL**) followed by the number (**0-7**). As volume is increased upward, the beep sound (if enabled) also increases, and vice-versa. When the minimum and maximum volume settings are reached, a unique tone will sound.



### **Monitor/Display Backlight Button (2)**

This button is used to check activity on the current frequency before transmitting. Check activity by pressing the Monitor (M) Button longer than 2 seconds; the  icon will appear on the display and you will hear static if frequency is clear. **Do not transmit if you hear conversation.** Hold down the Monitor Button again longer than 2 seconds and the  icon will disappear from the display.

The monitor function will temporarily bypass the squelch setting and play all signals on a given channel. This feature is useful when communicating with other parties at extreme range.

By pressing the monitor button momentarily, the LCD backlight is turned on; the LCD backlight will turn off automatically in about 5 seconds, unless the monitor button is pressed momentarily once again.

### **Push To Talk (PTT) Button (4)**

Pressing and holding this button will allow you to speak to any transceiver that is set to the same channel and privacy code setting as yours. Hold the transceiver approximately 1 to 2 inches from your face as you speak into the built in microphone (12). After you have finished speaking, release the PTT Button to allow reception of incoming signals. It is not possible to transmit and receive at the same time. The dual Transmit/Monitor LED at the upper right corner of the LCD Panel (8) will light **red** while the PTT Button is pressed and the transmit signal icon (  ) in the upper left corner of the display will display the relative strength of the transmitted signal. Releasing the button allows the unit to revert to standby mode. When receiving an incoming signal, the Transmit/Monitor LED indicator will light **green** and the received signal strength indicator (  ) will display the relative strength of the signal.

The PTT Button can also be used as a two-way call ringer. Pressing the button twice quickly will call another party on the same channel. The transmit LED will light **red** for approximately 3 seconds and then go out.

#### **Up Channel/Volume Button (16)**

In the standby mode, pressing this button will increment the listening volume. When in function edit mode this button will be used to adjust the unit's settings.

#### **Down Channel/Volume Button (13)**

In the standby mode, pressing this button will decrement the listening volume. When in function edit mode this button will be used to adjust the unit's settings.

#### **Function (F) Button (14)**

This button is used to select various feature settings in the GMRS and FRS modes.

#### **Emergency (EMG) Call Button (10)**

This radio has a quick access button (EMG) to the Emergency and Assistance Channel. This channel is not monitored by local authorities. When using this channel, **EMG** appears on the display. Pressing this button will set the transceiver to channel 20 (462.6750 MHz).

#### **External Speaker (SPK) and Microphone (MIC)/CHG Jacks (6)**

This set of jacks accepts both an Audiovox headset/microphone connector (optional) and the supplied wall charging adapter. For additional optional equipment and accessories for the GMRS1100-2CH, visit the Audiovox web site at [www.audiovox.com](http://www.audiovox.com).

#### **Scan/Lock Button (11)**

Press this Button momentarily to enable or disable the scan mode. Press and hold the button for more than 1 second to lock or unlock the key pad. All buttons will be locked in the lock mode except PTT and Monitor (M). When the keypad is locked, the (  ) icon will display in the top left corner.

## Operating Modes and Features

### GRMS/FRS Operation:

- From GMRS/FRS standby mode, press and hold the PWR button for 2 seconds to turn on power.
- Press the Function (F) button so the Channel number flashes.
- Select the desired channel with the Up (16) and Down (13) Buttons. When receiving a call, the signal strength meter appears to indicate incoming received signal strength and the Monitor section of the Transmit/Monitor LED(9) lights **green**.
- Press and hold the PTT button (4) to transmit, then speak into the microphone clearly and slowly. The Transmit section of the Transmit/Monitor LED (9) lights **red**.
- Release PTT Button (4) to receive.
- Communication can only be accomplished when the channel and CTCSS tone frequency of at least two parties are the same.
- The **CTC** icon will be displayed on the LCD panel if the CTCSS tone frequency function is enabled.

### Channel Selection

In order to communicate with other GMRS/FRS units, both transmitting and receiving party must be on the same frequency.

The GMRS1100-2CH has 22 channels (frequencies) (1-22) indicated by the large digits on the LCD display panel. Channels 1 through 7 are the shared GMRS/FRS channels. Channels 8-14 are FRS only channels, while channels 15-22 are assigned GMRS only channels. If an FRS only channel (8-14) has been selected, the **HI** or **LO** icon will not be displayed on the LCD panel; otherwise, for channels 1-7 (GMRS/FRS) and 15-22 (GMRS only) the **HI** or **LO** icon will be displayed. Communication with Audiovox GMRS/FRS and compatible units is possible on these 22 channels. Before transmitting on the selected channel, press the Monitor (M) Button (2) to check the activity on that channel. If there is activity on the selected channel, change to another channel that is clear.

To change the channel:

- From GMRS/FRS standby mode, press the Function (F) button (14) until the channel number flashes.
- Press the Up Button (16) briefly to move to the next higher main channel number.
- Press the Down Button (13) briefly to move to the next lower main channel number.
- Press the PTT or PWR button momentarily to confirm selection.

### **CTCSS Mode (Sub-Channel) Selection**

The Coded Tone Controlled Squelch System (CTCSS) has 38 Sub-Frequencies. This feature allows you to utilize the coded squelch tones (1-38) within a main channel and enables you to communicate with another party on the same main channel using the same subcode. (This filters out unwanted transmissions without the same coded squelch tone). Since there are 38 CTCSS Sub-channels for each main channel, a different subcode may be selected for each of the 22 channels.

To change the CTCSS Sub-channel:

- From GMRS/FRS standby mode, press the Function (F) Button twice; a flashing **oF** or sub-channel number is displayed.
- Press the Up or Down button to select the desired sub-channel for use (**01-38**).
- Press the PTT or PWR button to confirm selection.

The CTCSS mode can be turned off by selecting the **oF** icon as the setting.

**NOTE:** To communicate with other GMRS/FRS units, they must be switched to the same channel and CTCSS subcode. To communicate with other GMRS units that do not have subcodes, switch your unit to the same channel with the subcode set to **oF**.

The CTCSS subcodes do not prevent others from hearing your transmission. This will only allow you to ignore all traffic on a given channel not using the same subcode.

## Transmit Power Selection Mode (GMRS Channels Only)

This feature permits selection of the transmitting power level to high or low. Using low power, the unit will have a lower transmit range, but battery life will be increased.

**NOTE:** You will find that for the majority of your needs, the low-power setting will provide adequate communications on all channels; there should seldom be any need to use high power, except in situations where you need absolute maximum range. Using low power will greatly extend battery life. We suggest you experiment with switching between low and high power. However, we do recommend that you **not change** this setting unless it proves to be necessary in your particular situation.

To access the transmitter power selection function:

- From GMRS standby mode, press the Function (F) Button 3 times until the **Po** indication appears with a flashing **Hi** or **Lo** indication on the display.
- Press the Up or Down button to toggle between the High and Low selections.
- Press the PTT or PWR button to confirm selection.

The display will indicate the current setting in standby mode.

## VOX Selection Mode

This option enables you to have hands-free conversation. When using the internal microphone/speaker or external microphone/headset (**purchased separately**), your voice or the signal is detected and the radio transmits and receives automatically. Your voice or nearby sound is detected and the radio transmits without the need to press the PTT button.

To set radio for VOX operation:

- From GMRS/FRS standby mode, press the Function (F) button four times until the **VOX** icon appears flashing on the display.
- Press the Up or Down button to select VOX On (if **oF** appears flashing) and the **1-5** VOX level sensitivity.

- Momentarily press the PTT or PWR button to confirm the VOX selection.
- The **VOX** icon will appear steady on the LCD display.

VOX can be turned off by selecting **oF** as the setting.

## Dual Watch Mode

This feature allows you to monitor two channels at the same time. While in dual watch mode, the unit will continuously monitor both the primary and dual watch channel. Received signals will be heard for 5 seconds, then the unit will resume scanning the two channels. Pressing the PTT button during a received transmission will set the unit to transmit on the same channel. Pressing the PTT button when no signal is received will set the unit to transmit on the primary channel.

To set the Dual Watch Mode:

- From GMRS/FRS standby mode, press the Function button five times; the **DW** icon appears flashing on the display together with a flashing channel number; or, If the dual watch mode is off, **oF** appears flashing.
- To enable the dual watch mode, press the Up or Down button; the dual watch channel number will flash and start to increment up or down as the Up or Down button is pressed.
- If you desire a subcode for the dual watch channel just selected, press the Function (F) button again to select the CTCSS code for the channel.
- Press the PTT or PWR button to confirm selection of the dual watch channel. The display will now alternate between the primary channel and the dual watch channel (with subcode) just selected.
- To cancel the dual watch mode, press the SCAN button momentarily.

## Button Beep (Key Tone)

This feature allows the transceiver to sound a confirmation tone whenever the following keys are pressed: Monitor (M) Button, Up/Down Buttons, Function Button, SCAN Button or the EMG Button.

To turn the key tones on or off:



- From GMRS/FRS standby mode, press the MODE Button six times until **bP**, the Bell (  ) icon, and **On** or **oF** flash on the LCD display.
- Press the Up or Down Button to toggle the key tone feature On or Off.
- Press the PTT or PWR button momentarily to confirm selection.

When the key tone feature is on, the Bell icon appears steady on the display, and the beep tones sound in response to button activation.

## Roger Beep Tone

The Roger Beep is a tone which is automatically transmitted whenever the PTT button is released. This tone alerts the receiving party that the transmission has been terminated intentionally.

To enable and disable the Roger Beep tone:

- From GMRS/FRS standby mode, press the Function (F) Button 7 times until **rb** appears on the display with the flashing Roger Beep icon (  ) and **On** or **oF**.
- Press the Up or Down Button to select the tone on or off as desired.
- When enabled, the tone icon (  ) appears steady on the display.
- Press the PTT or PWR button momentarily to confirm selection.

## Call Ringer Selection Mode

The transceiver provides 5 user-selectable call ringer melodies to alert you to an incoming call.

To select your favorite call ringer melody:

- From GMRS/FRS standby mode, press the Function (F) button 8 times; **CA** will appear on the display, together with a flashing number (or **oF**) between **01** and **05**, and an appropriate call ring.

- Press the Up or Down Button to preview and hear the 5 available call melodies.
- Press the PTT or PWR button momentarily to confirm selection.

Refer to the PTT button (4) to transmit ring signal.

## Channel Scan Operation

This feature allows you to monitor all channels automatically for valid signals. While scanning, you can transmit and receive. When a signal is received, the scan is interrupted and will return to scan mode approximately 5 seconds after reception is terminated.

**NOTE:** While the SCAN mode is active, the Function (F) button is inoperative. In addition, the scan mode will reduce the overall battery life since the battery save function is overridden.

To enable the channel scan mode:



- From GMRS/FRS standby mode, momentarily press the SCAN Button; **SCAN** will appear on the LCD display.
- The radio will automatically display each channel (1-22) in ascending order to find an active main channel.
- When unit doesn't find any signals and you want to transmit, press the PTT Button to return to primary channel operation. The transceiver will automatically resume scanning approximately 5 seconds after the communication is completed.
- If there is no activity and you want to leave the scan mode, press the SCAN button momentarily and the unit will return to normal operation; the **SCAN** icon will disappear from the LCD display.



## Key Lock Selection Mode

This feature prevents accidental channel change to the preferred settings of the unit. The Key Lock function temporarily disables the Up, Down and Function (F) Buttons.

To access the Key Lock selection menu:

- From FRS standby mode, press and hold the Scan Button for over 2 seconds to Lock the Key function; the (  ) icon appears on the display.
- The PTT and Monitor Buttons are not effected.
- To unlock the Key function, press and hold the SCAN button for at least 2 seconds; the icon (  ) disappears from the display.

**NOTE:** If the unit is turned off while Key Lock is on, the Key Lock mode will still be in effect when the unit is turned on again.



## Emergency and Assistance Channel Mode

This radio has a quick access button (EMG) to the Emergency and Assistance Channel. This channel is **NOT** monitored by local authorities.

To turn the Emergency Channel feature on or off:

- Press and release the EMG Button; **EMG** appears on the display together with a Channel **20** indication.
- When the transceiver is set to Emergency Channel 20, The transceiver transmits and receives on a special frequency (CH20: 462.6750 MHz).
- To turn off the Emergency Channel feature, press and release the EMG Button

### **Battery Alert**

When the battery icon (  ) blinks on the LCD panel, recharge unit or install fresh batteries. If the batteries are not replaced the (  ) icon will appear and an audio tone will sound to warn the user that the batteries must be replaced.

### **NOTES FOR GOOD COMMUNICATION**

1. The GMRS1100-2CH 22 channels are shared on a 'take turns' basis. This means other groups may be talking on any of the channels. A common code of ethics/courtesy is to switch to another vacant channel and not to attempt to talk over someone who is already using the channel you first selected.
2. The GMRS1100-2CH has been designed to maximize performance and improve transmission range in the field. To avoid interference, it is recommended that you do not use the units closer than 5 feet apart.
3. For best transmission results, always keep your mouth about 2-3 inches from the microphone (12) and speak slowly in a normal voice.
4. To increase battery life, avoid features such as Scan, Dual Watch and Weather Alert. These features will reduce operating time considerably.

## **Warning**

- Do not operate the transceiver unless you are licensed to do so.
- Remove the batteries from the transceiver if it is not expected to be used for long periods. This will eliminate the possibility of chemicals leaking from the batteries and corroding the transceiver.
- Avoid exposing the transceiver to water or extremes of temperature.
- Do not use this device in or near a mining facility, which uses remotely triggered explosives or in areas labeled "Blasting Area". Premature or accidental detonation may result.
- Do not attempt to modify or in any way increase the output of this transceiver. Its output is designed to meet the legal limits set by the FCC.
- Do not use this device or change its batteries in potentially explosive atmospheres as sparks in such areas could result in an explosion.
- Turn your transceiver off wherever posted notices restrict the use of radios or cellular telephones. Facilities such as hospitals may use equipment that is sensitive to RF energy.
- Turn your transceiver off on board aircraft when requested to do so.
- Do not place your radio in front of a vehicle's air-bag. If the air-bag deploys, it could propel the transceiver like a projectile causing bodily injury.

## Troubleshooting

<b>Problem</b>	<b>Possible cause</b>	<b>Correction</b>
No transmission while pressing the PTT Button	Weak batteries	Charge or replace batteries
	Incorrect battery polarity	Install the batteries following the directions in paragraph Installing the Batteries.
Weak or no signal received	Weak batteries	Charge or replace batteries
	Channel and privacy code not set the same as target transceiver	Adjust the transceiver's settings to match those settings of the target transceiver
	Volume level too low PTT Button inadvertently depressed	Increase volume level Release PTT Button
	Excessive radio interference on a particular channel Obstruction of radio signal	Change to a different channel Avoid operating in or near large buildings or vehicles
Unit beeps, but will not function when turned on	Batteries extremely discharged	Charge or replace batteries
Reception of unwanted signals	CTCSS privacy mode not on	Turn on the CTCSS privacy mode and set code number to match the setting of the target transceiver.
	Interference from electronic devices such as computers or TVs	Turn the devices off or move farther away from them.

## **Technical Specifications:**

### **General**

Frequency Range:

Channels 1 through 7 are  
shared with FRS radios.

Refer to frequency chart on next page.

Channels 8 through 14 are  
FRS only.

Refer to frequency chart on next page.

Channels 15 through 22 are  
GMRS only.

Refer to frequency chart on next page.

Channel Spacing

12.5kHz

Privacy Codes

38 for each main channel

Dimensions (W x H x D)  
(Without Antenna)

2.125 W x 4.0 H x 1.325 D  
(54.0 mm x 101.6 mm x 33.6 mm)

### **Power Supply**

Power Source

Alkaline Batteries, AAA (4), 6 VDC  
Ni-MH rechargeable, AAA (4),  
4.8 VDC, 650 mAh

Operating Time  
(Transmit: Receive: Standby)  
(5: 5: 90 ratio)  
(Based on alkaline batteries)

30 hours Low Power  
14 hours High Power

### **Receiver**

Useable Sensitivity

>-119 dBm

Maximum Audio Output Power

> 0.3 Watt maximum (8 Ohm )

Modulation Distortion

< 5% (1 kHz 70%)

### **Transmitter**

RF Output Power

1.8 Watts maximum (high power)

0.5 Watt maximum (low power)

Maximum Deviation

+/- 2.5 kHz

Modulation Distortion

< 5% (1 kHz 70%)

This transceiver complies with FCC regulations for use in the United States of America. Use in other countries may be prohibited or restricted by local regulation. Please check with the local regulating agency before using this device outside the United States of America.

## Main Channel Frequencies:

CHANNEL/TYPE	FREQ (MHz)	CHANNEL/TYPE	FREQ (MHz)
1 GMRS/FRS	462.5625	12 FRS	467.6625
2 GMRS/FRS	462.5875	13 FRS	467.6875
3 GMRS/FRS	462.6125	14 FRS	467.7125
4 GMRS/FRS	462.6375	15 GMRS	462.5500
5 GMRS/FRS	462.6625	16 GMRS	462.5750
6 GMRS/FRS	462.6875	17 GMRS	462.6000
7 GMRS/FRS	462.7125	18 GMRS	462.6250
8 FRS	467.5625	19 GMRS	462.6500
9 FRS	467.5875	20 GMRS	462.6750
10 FRS	467.6125	21 GMRS	462.7000
11 FRS	467.6375	22 GMRS	462.7250

**NOTE:** Channels 1 through 7 are shared with FRS radios.

Channels 8 through 14 are FRS only.

Channels 15 through 22 are GMRS only.

## Continuous Tone Coded Squelch System Tone Frequencies (in Hz)

CTCSS	Freq. Hz	CTCSS	Freq. Hz
1	67.0	20	131.8
2	71.9	21	136.5
3	74.4	22	141.3
4	77.0	23	146.2
5	79.7	24	151.4
6	82.5	25	156.7
7	85.4	26	162.2
8	88.5	27	167.9
9	91.5	28	173.8
10	94.8	29	179.9
11	97.4	30	186.2
12	100.0	31	192.8
13	103.5	32	203.5
14	107.2	33	210.7
15	110.9	34	218.1
16	114.8	35	225.7
17	118.8	36	233.6
18	123.0	37	241.8
19	127.3	38	250.3

\* oF = No Tone

## 90 DAY LIMITED WARRANTY

*Applies to Audiovox Family Radio and General Mobile Service Products.*

AUDIOVOX CORPORATION (the Company) warrants to the original retail purchaser of this product that should this product or any part thereof, under normal use and conditions, be proven defective in material or workmanship within 90 days from the date of original purchase, such defect(s) will be repaired or replaced with new or reconditioned product (at the Company's option) without charge for parts and repair labor.

To obtain repair or replacement within the terms of this Warranty, the product is to be delivered with proof of warranty coverage (e.g. dated bill of sale), specification of defect(s), transportation prepaid, to the warranty center at the address shown below.

The Company disclaims liability for communications range of this product.

This Warranty does not apply to any product or part thereof which, in the opinion of the Company, has suffered or been damaged through alteration, improper installation, mishandling, misuse, neglect, accident, or by removal or defacement of the factory serial number/bar code label(s). THE EXTENT OF THE COMPANY'S LIABILITY UNDER THIS WARRANTY IS LIMITED TO THE REPAIR OR REPLACEMENT PROVIDED ABOVE AND, IN NO EVENT, SHALL THE COMPANY'S LIABILITY EXCEED THE PURCHASE PRICE PAID BY PURCHASER FOR THE PRODUCT.

This Warranty is in lieu of all other express warranties or liabilities. ANY IMPLIED WARRANTIES, INCLUDING ANY IMPLIED WARRANTY OF MERCHANTABILITY, SHALL BE LIMITED TO THE DURATION OF THIS WRITTEN WARRANTY. ANY ACTION FOR BREACH OF ANY WARRANTY HEREUNDER INCLUDING ANY IMPLIED WARRANTY OF MERCHANTABILITY MUST BE BROUGHT WITHIN A PERIOD OF 30 MONTHS FROM DATE OF ORIGINAL PURCHASE. IN NO CASE SHALL THE COMPANY BE LIABLE FOR ANY CONSEQUENTIAL OR INCIDENTAL DAMAGES FOR BREACH OF THIS OR ANY OTHER WARRANTY, EXPRESS OR IMPLIED, WHATSOEVER. No person or representative is authorized to assume for the Company any liability other than expressed herein in connection with the sale of this product.

Some states do not allow limitations on how long an implied warranty lasts or the exclusion or limitation of incidental or consequential damage so the above limitations or exclusions may not apply to you. This Warranty gives you specific legal rights and you may also have other rights which vary from state to state.

AUDIOVOX CORPORATION, 150 MARCUS BLVD., HAUPPAUGE, NEW YORK 11788  
1-800-290-6650

128-5385A