

---

# D1620

**PORTABLE 6.2" LCD MONITOR AND DVD PLAYER**

---

**Notice:**

This Product incorporates copyright protection technology that is protected by method claims of certain U.S. Patents and other intellectual property rights owned by Macrovision Corporation and other rights owners. Use of this copyright protection technology must be authorized by Macrovision Corporation, and is intended for home and other limited viewing uses only unless otherwise authorized by Macrovision Corporation. Reverse engineering or disassembly is prohibited.

## Contents

A. Introduction .....	1
B. Cautions and Warnings .....	1
C. Contents .....	3
D. Powering and installation .....	3
E. Controls, Indicators, and Connectors .....	4
F. Loading and Playing a Disc .....	5
G. SETUP .....	6
H. Basic Operation .....	14
I. Menu .....	15
J. Display .....	15
K. Playing Audio CDs .....	21
L. Playing MP3 Discs .....	23
M. Playing JPG file .....	25
N. Connecting to a TV or another monitor .....	27
O. Specifications .....	28
P. Rechargeable Battery Installation and Use .....	28
Q. Troubleshooting .....	31

## **A. Introduction**

Thank you for choosing the D1620. The main features include a 6.2" Wide Screen (16:9 Aspect Ratio) Liquid Crystal Display (LCD) monitor and a DVD player. The unit applies the latest state of the art electronics and is designed for use in hotels, offices, vehicles or your home. The unit is constructed to provide years of reliable, trouble-free service, and is compact so that you can take it with you anywhere and is designed for quick and easy installation. Please read the entire instruction manual supplied with this product prior to using. The documentation will assist you in installing the system properly to obtain the best equipment performance. Please save this manual for later use.

## **B. Cautions and Warnings**

### ***1. Placement***

To prevent fire or electric shock, do not expose this appliance to rain or moisture. Do not place the set on an unstable cart, stand, tripod, bracket or table to prevent it from falling. Keep the unit away from strong magnets, heat sources, direct sunlight and excessive dust. If the unit is brought directly from a cold to a warm location, moisture may condense inside the unit. When you move it from a cold to a warm location, wait for about one hour before operating the unit, or remove the disc and leave the unit turned on until the moisture evaporates.

### ***2. Installation***

Ensure that the D1620 is installed in accordance with the instructions and illustrations provided in this manual.

### ***3. Caution***

Do not push objects of any kind into the unit through openings; do not spill or spray liquid of any kind on or in the system (this may result in a fire or electric shock). Do not place anything heavy on the unit. To ensure proper ventilation and proper operation, never cover or block the slots and openings with a cloth or other material.

Keep the unit away from an open flame such as, fire, candle etc, It is hazardous to replace the battery with a battery not designed for this model. Replace the battery only with the same or equivalent type. In order to protect the environment, please dispose the battery properly. Do not use the unit in temperatures higher than 104 degrees Fahrenheit or 40 degrees Celcius.

#### **4. *Disassemble***

Do not attempt to disassemble the cabinet. There is a risk of electric shock and/or exposure to Laser Radiation. Contact qualified service personnel if your system needs repair.

#### **5. *Cleaning Unit***

When cleaning, make sure the system is unplugged from the power source. Do not use liquid cleaners or aerosol cleaners. Use a cloth lightly dampened with water for cleaning the exterior of the system only.

#### **6. *Disc***

Do not use irregularly shaped discs such as heart or star-shaped discs as they may cause the unit to malfunction. Do not stick paper, tape or glue on the disc. Do not expose the disc to direct sunlight or heat sources. Do not touch the surface of disc. Handle the disc by its edge. Clean the disc by wiping the disc from the center out with a cleaning cloth. Remove the disc from the unit and store it in its case after playing. Some playback operations of discs may be intentionally fixed by software producers. Since this unit plays discs according to the disc contents the software producers designed, some playback features may not be available. Also refer to the instructions supplied with the discs.

### C. Contents

1. 1 x 6.2" LCD Monitor & DVD Player Combo
2. 1 x Remote Control with battery (CR2025)
3. 1 x A/V Cable
4. 1x DC Power Adapter
5. 1 x AC to DC Adapter
6. 1 x Instruction Manual
7. 1 x Rechargeable Battery

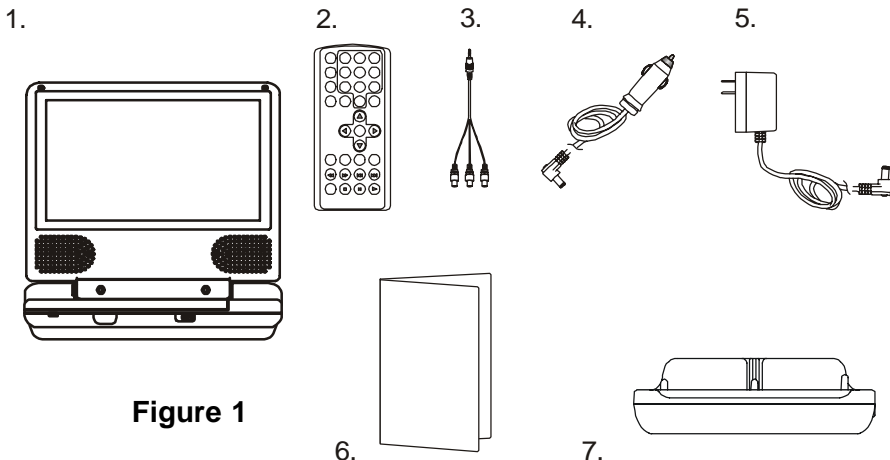

Figure 1

### D. Powering and installation

#### 1. Powering the system indoors (Refer to Figure 1)

Plug one end of the AC to DC adapter into the DC 9V jack on the right side of the main unit, then plug the other end into the 120V AC power outlet.

#### 2. Powering the system in a car (refer to Figure 1)

Plug one end of the DC Power adapter into the DC 9V jack on the unit, then plug the other end into the vehicle power outlet.

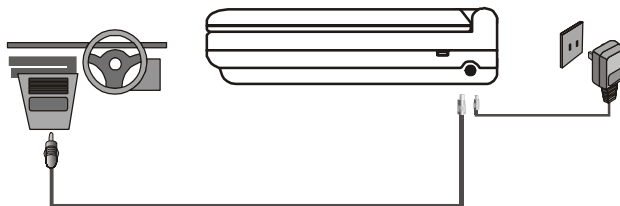
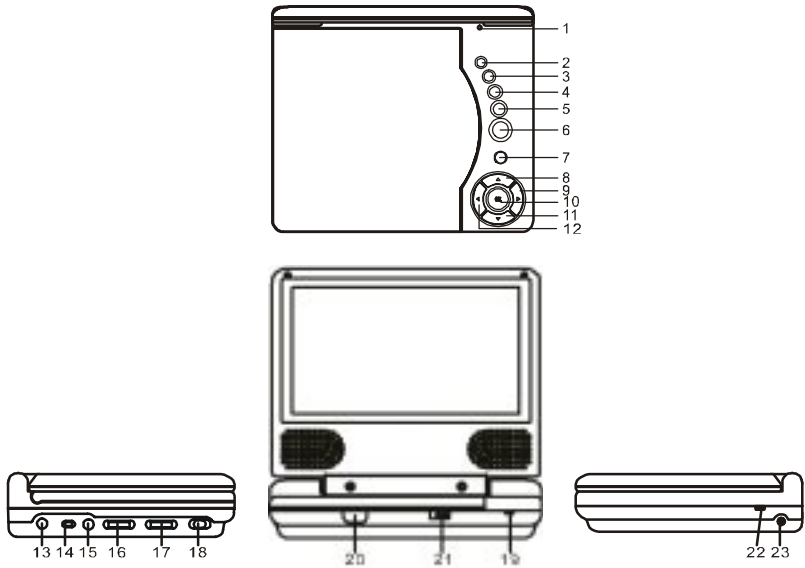

Figure 2

## E. Controls, Indicators, and Connectors

### 1. Unit View (Refer to Figure 3)

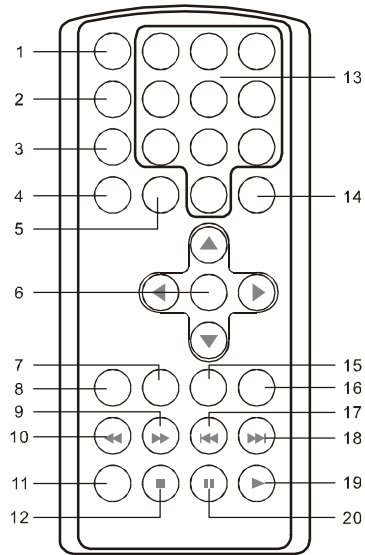

**Figure 3**

- |                              |                           |
|------------------------------|---------------------------|
| 1) LCD Panel Shut Off Switch | 13) A/V Jack              |
| 2) Wide Button               | 14) In/Out Switch         |
| 3) Stop Button               | 15) Headphone Jack        |
| 4) Previous Button           | 16) Volume Control        |
| 5) Next Button               | 17) Brightness Control    |
| 6) Play Button               | 18) Power On/Off Switch   |
| 7) Menu                      | 19) Power LED             |
| 8) Up Button                 | 20) Remote Control Sensor |
| 9) Right Button              | 21) Open Button           |
| 10) OK Button                | 22) Charge LED            |
| 11) Down Button              | 23) DC 9V Input Jack      |
| 12) Left Button              |                           |

## 2. Remote Control View (Refer to Figure 4)

- 1) Display Button
- 2) Angle Button
- 3) Subtitle Button
- 4) Audio Button
- 5) Zoom Button
- 6) UP/DOWN/LEFT/RIGHT/  
ENTER Buttons
- 7) Return Button
- 8) A-B Button
- 9) Forward Button
- 10) Reverse Button
- 11) Slow Button
- 12) Stop Button
- 13) Numeric Keypad
- 14) Setup Button
- 15) Menu Button
- 16) Repeat Button
- 17) SKIP- Button
- 18) SKIP+ Button
- 19) Play Button
- 20) Pause Button



**Figure 4**

## F. Loading and Playing a Disc

- a. After connecting power to the unit, power on “DVD player” with the power switch. The power indicator will light.
- b. Open the disc cover by pressing OPEN, and place a disc into the tray with the label side facing up.
- c. Close the cover by pressing “PRESS” on the disc cover. The unit will load the disc and start playing.
- d. Rotate the BRIGHTNESS and VOLUME controls to adjust the LCD’s brightness and the DVD player’s volume.
- e. To stop playing a disc, press STOP.
- f. To turn off the DVD player, slide the power ON/OFF switch to OFF. The DVD player’s power indicator will turn off.



## **G. Setup**

Press 'SETUP' to display the Main screen of the Setup Menu on the screen. Press 'SETUP' again to exit the Setup Menu and the unit will resume it's last playback mode.

### **Figure 5. Main Setup Menu Screen**

- 1) Press "SETUP", the 'General Setup Page' will display on screen.
  - a).Select 'TV Display' using the UP/DOWN button, and then press RIGHT to enter the submenu. Select the TV display mode on the screen using UP/DOWN, and press ENTER to confirm the setting. Press LEFT to return.
    - \* Normal/PS: When the player is connected to a normal TV, and a wide picture is shown on the full screen.
    - \* Normal/LB: When the player is connected to a normal TV, and a wide picture is shown on the screen with a black strip at both the top and bottom of the screen.
    - \* Wide: When the player is connected to a wide screen TV, a wide picture is shown on the full screen.

### **Figure 6. TV Display Screen Display**

b).Select 'TV Type' using the UP/DOWN button, and then press the RIGHT button to enter the submenu. Choose TV Type using the UP/DOWN button and then press ENTER to confirm the setting. Press the LEFT button to return.

### **Figure 7. TV Type Screen Display**

c).Select 'Angle Mark' using the UP/DOWN button, and then press the RIGHT button to enter the submenu. Choose Angle Mark on or off using the UP/DOWN button and then press ENTER to confirm the setting. Press the LEFT button to return.

### **Figure 8. Angle Mark Screen Display**

\* On: The screen will show the angle mark icon. (\*If an angle option is available).

\* Off: The screen will not display the Angle Mark

**NOTE:** Not all discs contain above features. The above features are disc dependent.

d). Select 'Screen Saver' using the UP/DOWN button, and then press the RIGHT button to enter the submenu. Choose Screen Saver on or off using the UP/DOWN button and then press ENTER to confirm the setting. Press the LEFT button to return.

### Figure 9. Screen Saver Screen Display

\*On: Enables screen saver

\*Off: Disables screen saver (off)

\***NOTE:** The DVD player will enter the Screen Saver mode after approximately five minutes if the same image remains on the screen.

d. Select "Last Memory" by using the UP/DOWN button.

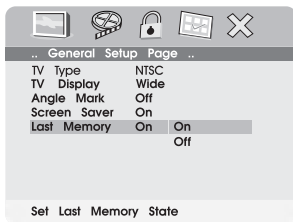

### Figure 10. Last Memory Screen Display

\*on: The unit will return to the last position on the disc.

\*off: The unit will not return to the last position on the disc.

Note: The Last position memory function will only work if the disc door remains closed and the power is on.

2) Select “Video quality Setup” by using the LEFT/RIGHT button. Press “enter” to enter the video quality setup page.

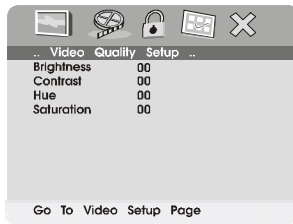

**Figure 11. Video Quality Menu**

a. Select “Brightness” by using the UP or DOWN button, then press “Enter”. You can change the Brightness by pressing the LEFT or RIGHT button. To exit “Brightness Setting”, press “Enter” again to return to the main Menu.

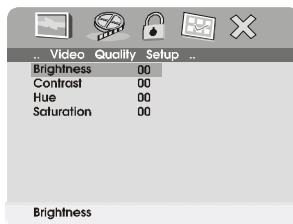

**Figure 12. BRIGHTNESS Screen Display**

- b. Select “Contrast” by using the UP or DOWN button, then press “Enter”. You can adjust the Contrast by pressing the LEFT or RIGHT buttons.



**Figure 13. Contrast Screen Display**

To exit “Contrast” setting, press “ENTER” again to return to the main Menu.

- c. Select “Hue (Tint)” by using the UP or DOWN button, then press “Enter”. You can adjust the Hue by pressing the LEFT or RIGHT buttons.



**Figure 14. Hue(Tint) Screen Display**

To exit “Hue (Tint)” setting, press “ENTER” again to return the main Menu.

- d. Select “Saturation (Color)” by using the UP or DOWN button, then press “Enter”. You can adjust the Saturation by pressing the LEFT or RIGHT buttons.

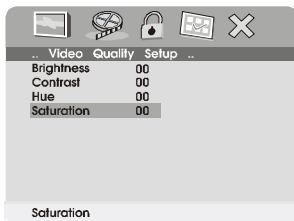

**Figure 15. Saturation(Color) Screen Display**

To exit “Saturation (Color)” setting, press “Enter” again to return to the main Menu.

3).Select “Password” using the LEFT or RIGHT button, then press the RIGHT button to enter the submenu.



**Figure 16. Password Change Menu Screen Display**

Press ‘ENTER’ to enter the Password Change Page. Input the Old Password or the Default Password, the New Password, and the Confirmed New Password. Press ‘ENTER’ to confirm the change.

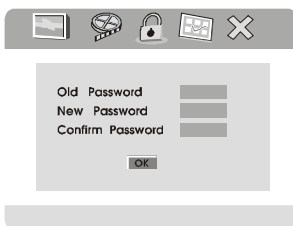

**Figure 17. Password Verify Input Screen Display**

**NOTE:** The Default Password is **3308**. This password is always effective even after you have selected your own password and changed it. To avoid the possibility of others using the default password to set the parental level and change the password, you should record this default password in another area and delete it from this manual. Some discs can be limited depending on the age of users while some discs cannot.



**Figure 18. Password Change Menu Screen Display**

- 4).With no disc inside the player select “PREFERENCES” using the LEFT or RIGHT button, then press ‘ENTER’ to enter the Preferences Page.
- a. Select ‘Audio’ using the UP/DOWN button, then press ‘RIGHT’ to enter the submenu. Select the audio language you desire using the UP or DOWN button, then press ‘ENTER’ to confirm the setting. Press LEFT to return.

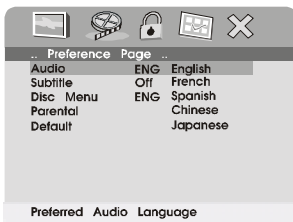

**Figure 19. Preference Audio Language Screen Display**

- b. Select “Subtitle” using the UP or DOWN button, then press RIGHT to enter the submenu. Select the desired subtitle language or SUBTITLE OFF using the UP or DOWN button, then press ‘ENTER’ to confirm the setting. Press ‘LEFT’ to return.

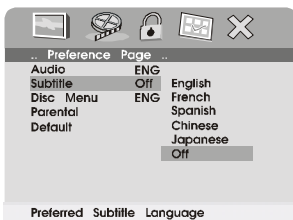

**Figure 20. Preference Subtitle Language Screen Display**

- c. Select 'DISC MENU' using the UP or DOWN button, then press 'RIGHT' to enter the submenu. Select the Disc Menu language you desire using the UP or DOWN buttons, then press 'ENTER' to confirm the setting. Press 'LEFT' to return.



**Figure 21. Preference DISC Menu Language Screen Display**

**Note:** Language and subtitle selection is only available for discs that are recorded in the above listed languages. If the selected, language is not available, the player will play and display on the screen the original recorded language contained in the disc.

- d. Select 'PARENTAL' using the UP or DOWN button, then press RIGHT to enter the submenu.

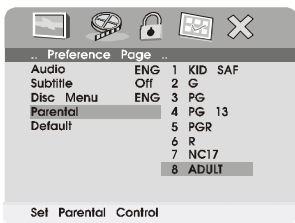

**Figure 22. Parental Preference Screen Display**

Select the parental level you desired using the UP or DOWN button for discs with lock-out function or multiple rating levels. These are listed from the lowest level (1 Kid Safe) to the highest level (Adult). Enter a 4 digit password, then press ENTER to confirm the parental level setting.

**NOTE:** The level of 8 Adult is the factory default.



e. Select 'DEFAULT' using the UP or DOWN button, then press RIGHT to enter the submenu. Press ENTER to make the setting return to the factory-set mode.

**NOTE:** The parental setting is not affected by the default reset function.

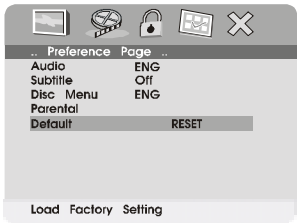

**Figure 23. Loading Factory Setting Screen Display**

## H. Basic Operation

POWER	Turn the unit on/off
OPEN	Remove/load the disc
PLAY	Start Play/Execute item or setting
SLOW	Play at 1/2, 1/4, 1/8 or 1/16 times speed
PAUSE	Still Picture
STOP	(1 time) Stop at the present playing point / (2 times) Stop playing
NEXT	Go to the next chapter, track or scene during playback
PREVIOUS	Go back to the previous chapter, track or scene during playback
FORWARD	Scan forward at 2, 4, 8, 16 or 32 times speed
REVERSE	Scan backward at 2, 4, 8, 16 or 32 times speed
LEFT/RIGHT/UP/DOWN	Used for Menu Navigation
ENTER	Execute item or confirm setting
NUMBERS	Select item or setting
RETURN	Return
MENU	Display the main menu of the disc
REPEAT	Repeat playing title, chapter, or track
A-B	Repeat a specific portion from point A to point B of the disc
DISPLAY	Display information (title, chapter, track, time, etc.).
ANGLE	Change the viewing angle of the scene
SUBTITLE	Select the subtitle language and turn it on/off
AUDIO	Select the audio language
ZOOM	Enlarge an image to 2, 3, or 4 times the original size.
SETUP	Display the setup menu to select and set items, and exit the setup menu.

## I. Menu

A DVD is divided into sections called titles and chapters. When you play a DVD, a root menu of the disc will appear on the screen of your TV or Monitor. The contents of the menu vary from disc to disc. Press MENU during playback to display the menu. Some DVDs only allow you to select disc playback options using the DVD root menu.

## J. Display (Display Contents Vary From Disc to Disc)

### 1. PLAYING TIME AND REMAINING TIME

- a. During playback press the 'DISPLAY' button to display the current Title Number (1), the total Number of Titles (2), the current Chapter Number (3), the total Number of Chapters (4), and the Playing elapsed Time for the title (5). The heading will disappear automatically after 3 seconds if no buttons are pressed.

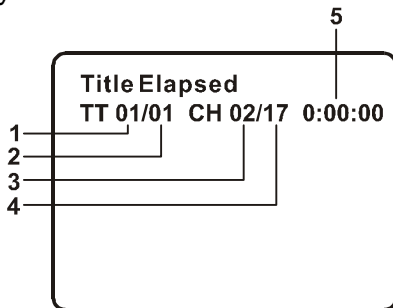

**Figure 24. Title, Chapter Number, and Time Screen Display**

- b. Press DISPLAY again to display the Remaining Time of the title. The heading will disappear automatically in 3 seconds.

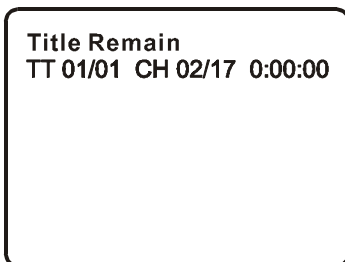

**Figure 25. Title Remaining Time Screen Display**

- c. Press 'DISPLAY' a 3rd time to display the Elapsed Time for the chapter. The heading will disappear automatically in 3 seconds.

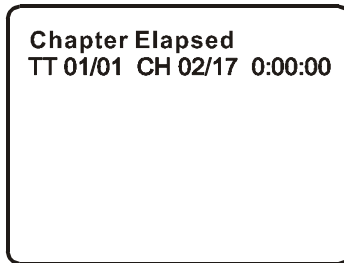

**Figure 26. Chapter Elapsed Time Screen Display**

- d. Press 'DISPLAY' a 4th time to display the Remaining Time for the chapter. The heading will disappear automatically in 3 seconds.

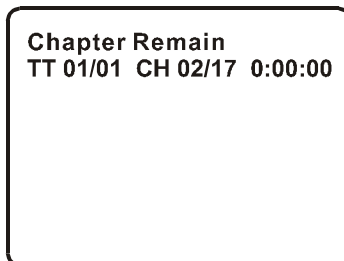

**Figure 27. Chapter Remaining Time Screen Display**

- e. Press 'DISPLAY' a 5th time to exit, 'DISPLAY OFF' will be displayed and will disappear automatically in 3 seconds.

## **2. ANGLE**

During playback of a disc, press 'ANGLE' to display the available angles for discs containing multi-angles\*, with the current angle number (1) and the total number of angles (2) displaying. Press 'ANGLE' to select another angle, then press again to exit and return to the normal viewing angle. The angle mark will disappear automatically if the 'ANGLE' button is not pressed again within 3 seconds.

**\*NOTE:** Not all discs contain this feature.

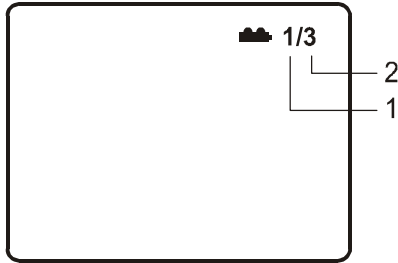

**Figure 28. Angle Screen Display**

### **3. SUBTITLE**

During disc playback press 'SUBTITLE' to select the subtitle language you desire\*, with the current Subtitle Language Number (1) and the total Number of Subtitle Languages (2) displayed. If there are multiple languages press 'SUBTITLE' again to select another subtitle language. To turn subtitles OFF, press the 'SUBTITLE' button until 'SUBTITLE OFF' is displayed. The Subtitle display will disappear automatically if the 'SUBTITLE' button is not pressed again within 3 seconds.

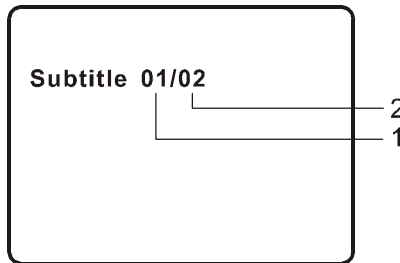
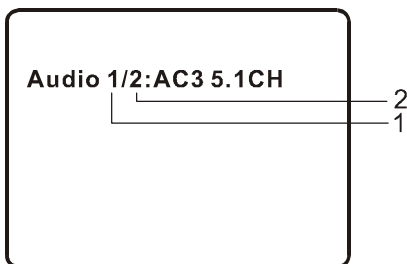

**Figure 29. Subtitle Screen Display**

\* Some DVDs only allow access to this function through the DVD menu.

#### 4. AUDIO

During playback press 'AUDIO' to select the audio language you desire\*, with the current Audio Channel Number (1) and the total number of Audio Channels (2) displayed. Press AUDIO again to select another audio language. The audio display will disappear automatically if the 'AUDIO' button is not pressed within 3 seconds.

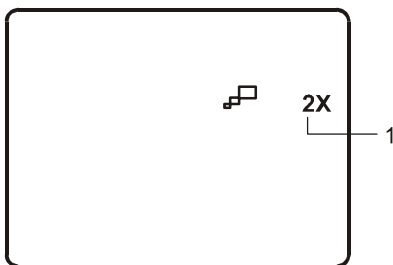

**Figure 30. Audio Language Screen Display**

\* Some DVDs only allow access to this function through the DVD menu.

#### 5. ZOOM

During playback press 'ZOOM' to enlarge the picture by 2x, 3x or 4X. (1) Press "zoom" one time, the picture will be enlarged 2X. (2) Press "zoom" a 2nd time, the picture will be enlarged 3X. (3) Press "zoom" a 3rd time, the picture will be enlarged 4X. (4) Press "zoom" a 4th time, the picture will return to normal size.



**Figure 31. ZOOM Screen Display**

## 6. A-B REPEAT

a. During playback press 'A-B' the to set the Starting Point A.



**Figure 32. A-B Repeat Starting Point Screen Display**

b. Press 'A-B' a second time to set the Ending Point B and the player will repeatedly play the part between Point A and Point B.



**Figure 33. A-B Repeat Ending Point Screen Display**

c. Press A-B a third time to cancel A-B repeat and resume normal playback.



**Figure 34. A-B Repeat Cancelled Screen Display**

## 7. REPEAT

- a. During playback press 'REPEAT' once to repeatedly play the current chapter.

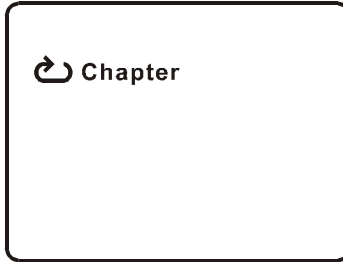

**Figure 35. Chapter Repeat ON Screen Display**

- b. During playback press 'REPEAT' again to repeatedly play the current title.



**Figure 36. Title Repeat ON Screen Display**

- c. During playback press 'REPEAT' a 3rd time to repeat all Chapters and Titles.



**Figure 37. ALL Screen Display**



d. Press "REPEAT" a 4th time, to resume normal play.

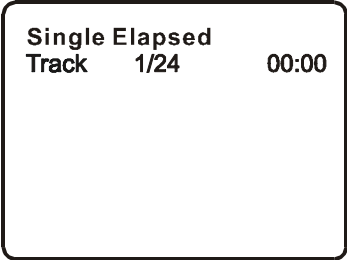

**Figure 38. Repeat Off Screen Display**

**K. Playing Audio CD's**

When playing an audio CD press the DISPLAY button on the remote to view time playback information. The options below show you what information is available using this function.

a. The current track and playing time of that track will be displayed on the screen.



**Figure 39. Single Elapsed Screen Display**

b. Press 'DISPLAY' one time and *Single Remain* appears along with the current track playing and the amount of time left.

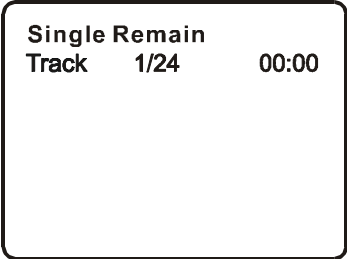

**Figure 40. Single Remain Screen Display**

- c. Press 'DISPLAY' two times and *Total Elapsed* appears along with the current track playing and the total time that the CD has been playing.

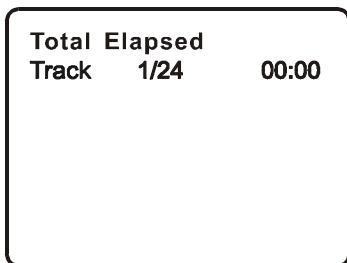

**Figure 41. Total Elapsed Screen Display**

- d. Press 'DISPLAY' three times and *Total Remain* appears along with the current track playing and the amount of time remaining on the CD.

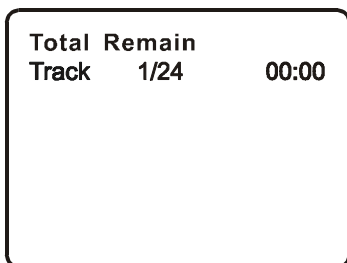

**Figure 42. Total Remain Screen Display**

- e. Press 'DISPLAY' four times and "*Display Off*" will appear momentarily then disappear. The CD time information will not be displayed.

### **Using the REPEAT Feature**

The default mode for the Repeat feature is Off. Pressing REPEAT consecutively changes the repeat options:

- *Track-* repeats the track that is playing.
- *All-* repeats the disc that is playing.
- *Off*

As you toggle through the options, the repeat option changes. The selected repeat option loops repeatedly until you turn it off.

## L. Playing MP3 Discs

MP3 is a format for storing digital audio. An audio CD-quality song is compressed into the MP3 format with very little loss of audio quality while taking up much less disc space. CD-R /RW discs that have been encoded in MP3 format are compatible with this system.

Playback modes:

**Folder** (normal playback)

**Single**

**Repeat One** (repeat playback of a song)

**Repeat Folder** (repeat playback of a specific folder)

Insert an MP3 CD, the DVD player will initialize the disc and the directory (folder) will be shown on the TV screen.

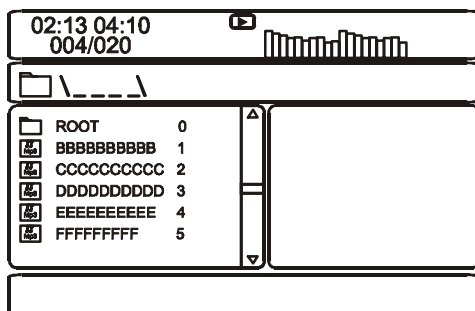

**Figure 43. MP3 Menu Screen Display**

When an MP3 disc is inserted into the unit, the menu screen appears automatically. You can use the menu screen to change folders and songs. The system plays the songs in the order they were burned onto the disc.

1. Press the ▲ or ▼ button to choose a folder from the folder list on the left side of the screen.
2. Press ENTER to select the highlighted folder. The songs available under the folder will be listed.
3. Use ▲ or ▼ button to choose a song from the list. Press ENTER to select and begin playback of the highlighted song.

Use the ►► ( NEXT ) button to move to the next song. Press the ◀◀ (PREVIOUS) button to move to the beginning of the previous song.

### **Using The Repeat Feature**

The default mode for the Repeat feature is OFF. Pressing REPEAT consecutively changes the repeat options:

- SINGLE
- REPEAT ONE
- REPEAT FOLDER
- FOLDER

As you toggle through the options, the repeat option changes. The selected repeat option loops repeatedly until you turn it off.

### **NOTICE**

- “  ” icon in front of a file name indicates that this is a folder, not an MP3 file.
- “MP3” icon in front of a file name indicates that this is a MP3 file.

## **M. Playing JPEG file**

- 1) Load the JPEG Disc into tray and close the cover.
- 2) Select JPEG file by pressing “UP/DOWN” button.
- 3) You can preview the JPEG file by pressing “Play” or “ENTER”.
- 4) Pressing the “Left Key“ will rotate the picture counterclockwise.  
Pressing the “Right Key“ will rotate the picture clockwise.
- 5) When browsing the photos, you can reverse the photo horizontally by pressing “Up” key, or you can reverse the photos vertically by pressing “Down” key.
- 6) When you browse the JPEG file, press “display”, there will be different refresh mode below.
  - a. Press “display” first time, “WIPE TOP” will display on the screen, the picture will refresh from top to bottom.
  - b. Press “display” 2nd time, “WIPE BOTTOM” will display on the screen, the picture will refresh from bottom to top.
  - c. Press “display ” 3rd time, “WIPE LEFT” will display on the screen, the picture will refresh from left side to right side.
  - d. Press “display ” 4th time, “WIPE RIGHT” will display on the screen, the picture will refresh from right side to left side.
  - e. Press “display” 5th time, “DIAGONAL WIPE LEFT TOP” will display on the screen, the picture will refresh from left top to right bottom.
  - f. Press “ display ” 6th time, “DIAGONAL WIPE RIGHT TOP” will display on the screen, the picture will refresh from right top to left bottom.
  - g. Press “display ” 7th time, “DIAGONAL WIPE LEFT BOTTOM” will display on the screen, the picture will refresh from left bottom to right top.
  - h. Press “display ” 8th time, “DIAGONAL WIPE RIGHT BOTTOM” will display on the screen, the picture will refresh from right bottom to left top.

- i. Press “display” 9th time, “EXTEND FROM CENTER H” will display on the screen, the picture will refresh from horizontal center to both sides.
  - j. Press “display” 10th time, “EXTEND FROM CENTER V” will display on the screen, the picture will refresh from vertical center to both sides.
  - k. Press “display” 11th time, “COMPRESS TO CENTER H” will display on the screen, the picture will refresh from top and bottom to center.
  - l. Press “display” 12th time, “COMPRESS TO CENTER V” will display on the screen, the picture will refresh from right and left to center.
  - m. Press “display” 13th time, “WINDOW H” will display on the screen, the picture will refresh from four window’s top side to bottom side.
  - n. Press “display” 14th time, “WINDOW V” will display on the screen, the picture will refresh from four window’s left side to right side.
  - o. Press “display” 15th time, “WIPE FROM EDGE TO CENTER” will display on the screen, the picture will refresh from 4 edges to center.
- 7) When previewing the file, pressing “ANGLE, SUBTITLE, AUDIO, NUMBER, AB, RETURN, REW/FF, SLOW” a hand icon will appear on the display meaning that these options are not available.
  - 8) Press “Stop” to browse the JPEG file, “SLIDE SHOW” “MENU” will display on the screen.
  - 9) When browsing the picture, press “Stop” and thumbnail size picture will be displayed. You can select the picture you desire by using the UP/DOWN/LEFT/RIGHT/ENTER key.
  - 10) Press “Play” or “OK”, to preview the left top picture.
  - 11) You can return the root Menu by pressing “left” key.

## N. Connecting to a TV or another monitor

You can also connect the DVD player to a TV to enjoy high quality stereo sound and picture on another monitor.

1. Connect one end of the audio/video cable's black (1/8" plug) plug into the unit's A/V OUT jack, and connect the other end to the AUDIO INPUT jacks on your TV or Monitor (white = left channel, red = right channel).
2. Connect the yellow plug to the VIDEO INPUT jack on your TV or Monitor.

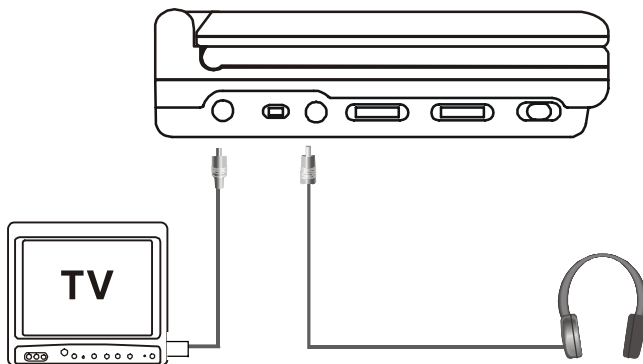

**Figure 44. Wired Headphones**

## O. Specifications

Compatible DISC Formats : DVD/CD/MP3

Signal system: NTSC/PAL

Panel size: 6.2 inch

DVD video format: Horizontal 720 pixel, vertical 480 pixel (NTSC)

Frequency response: 20 Hz to 20 kHz

Video output: 1 V<sub>p-p</sub>/75 Ohm, unbalanced

Audio output: 2 x 0.4 Watts

Audio S/N: Better than 60 dB

Dynamic range : Better than 85 dB

Laser: Semiconductor Laser, Wave Length: 650 nm/795 nm

Power source: DC 9V

Power consumption: 12 W

Operating temperature: 5~35°C

Weight : 0.78 kg

Dimensions (W x D x H): 6.5 X 5.59 X1.42inches  
165 x 142 x 36mm

Battery Type: Li-ion

## P. Rechargeable Battery Installation and Use

The player utilizes a set of long-life Li-ion batteries for a portable power supply. Li-ion batteries feature high storage capacity and low level of degradation. This means the Li-ion batteries do not have “Memory Effect” and thus can be recharged safely regardless of whether the battery is fully or only partially discharged. Please fully charge the battery at least 8 hours prior to first use.

**NOTE:** When the DVD player is used with the battery as a power source, ensure that the battery has been charged for at least eight hours prior to connecting it to the DVD player.

If you plan not to use the battery for an extended period of time (one week or longer), we recommend that you first fully charge the battery and store it away properly. For longer periods of storage, please



recharge the battery at least once every two months to maintain the battery in optimum condition. Under no circumstances short the battery terminals, store the battery in a metal container, or leave the battery in a humid or damp environment. Ideally, store the battery in an airtight container with desiccant or other dehumidifying agent. Each full recharge takes approximately five-hours and one full charge can provide power to the player for approximately 2 hours. During recharge, the red indicator will stay on. Once fully recharged, the red light will turn off. At this point you may remove the wall plug and stop charging.

### **Precautions related to Battery Recharge:**

1. Once the battery is fully discharged, immediately recharge (regardless of whether you plan to use battery or not) in order to maximize battery life.
2. To charge the battery, please connect the power jack directly into the DVD player and leave the POWER switch in the off position.

### **Using and Maintaining your Rechargeable Batteries**

1. Please make sure you always use **only** the AC adapter included with the player to recharge your batteries.
2. Recharge efficiency will degrade when environmental temperatures drop below 50°F (10°C) or exceed 95°F (35°C).
3. Please remove the battery from the player and store it properly if the player is not to be used for long time. During this period, please recharge the battery at least once every two months to avoid irreparable damage to the battery.

### Installing the Battery Pack:

1. First, make sure the player is in “Stop” mode and that the AC power supply has been disconnected.
2. Close the player cover.
3. Align the guide pins on the battery with the holes on the back of the unit. Push the battery towards the rear flank of the player until it locks into position. The lock position is indicated by a click. The unit will fit snugly to the player.



**Figure 45. Installing the DVD Player Battery**

### Removing the Battery Pack:

1. First, make sure the player is in “Stop” mode and the AC power supply has been disconnected.
2. Press the release button on the left side of battery.
3. Pull the battery from the unit.

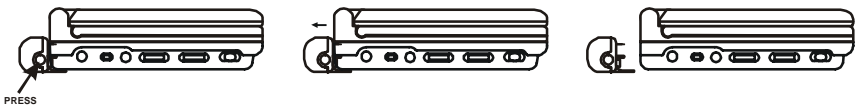

**Figure 46. Removing the DVD Player Battery**

## Q. Troubleshooting

PROBLEM	SOLUTION
No sound or distorted sound	<ul style="list-style-type: none"><li>• Make sure your DVD is connected properly. Make sure all cables are securely inserted into the appropriate jacks.</li><li>• Make sure the A/V in/out switch is set to Out.</li></ul>
Can't advance through a movie	<ul style="list-style-type: none"><li>• You can't advance through the opening credits and warning information that appears at the beginning of movies because the disc is programmed to prohibit that action.</li></ul>
The icon (  ) appears on screen	<p>The feature or action cannot be completed at this time because:</p> <ol style="list-style-type: none"><li>1. The disc's software restricts it.</li><li>2. The disc's software doesn't support the feature (e.g., angles)</li><li>3. The feature is not available at the moment.</li><li>4. You've requested a title or chapter number that is out of range.</li></ol>
Picture is distorted	<ul style="list-style-type: none"><li>• The disc might be damaged. Try another disc.</li><li>• It is normal for some distortion to appear during forward or reverse scan.</li></ul>
No forward or reverse scan	<ul style="list-style-type: none"><li>• Some discs have sections that prohibit rapid scanning or title and chapter skip.</li><li>• If you try to skip through the warning information and credits at the beginning of a movie, you won't be able to. This part of the movie is often programmed to prohibit skipping through it.</li></ul>

## Troubleshooting (Cont)

<b>PROBLEM</b>	<b>SOLUTION</b>
IR sensor inoperative	<ul style="list-style-type: none"><li>• Verify that the batteries in the remote are fresh.</li><li>• Verify that the remote sensor eye is not obstructed.</li></ul>
Disc won't play	<ul style="list-style-type: none"><li>• Check the type of disc you put into disc tray. This DVD only plays DVDs, CDs and MP3s.</li></ul>
Play starts then stops immediately	<ul style="list-style-type: none"><li>• Both the unit and the disc are coded by region. If the regional codes don't match, the disc can't be played. This DVD player is Region Number 1.</li><li>• The disc is dirty. Clean it.</li><li>• Condensation has formed. Allow player to dry out.</li></ul>



**AUDIOVOX**  
ELECTRONICS CORP.

## 90 DAY LIMITED WARRANTY

*Applies to Audiovox Video Products*

AUDIOVOX ELECTRONICS CORP. (the Company) warrants to the original retail purchaser of this product that should this product or any part thereof, under normal use and conditions, be proven defective in material or workmanship within 90 days from the date of original purchase, such defect(s) will be repaired or replaced with reconditioned product (at the Company's option) without charge for parts and repair labor.

To obtain repair or replacement within the terms of this Warranty, the product is to be delivered with proof of warranty coverage (e.g. dated bill of sale), specification of defect(s), transportation prepaid, to the Company at the address shown below.

This Warranty does not extend to the elimination of externally generated static or noise, to correction of antenna problems, to costs incurred for installation, removal or reinstallation of the product, or to damage to tapes, discs, speakers, accessories, or electrical systems.

This Warranty does not apply to any product or part thereof which, in the opinion of the Company, has suffered or been damaged through alteration, improper installation, mishandling, misuse, neglect, accident, or by removal or defacement of the factory serial number/bar code label(s). THE EXTENT OF THE COMPANY'S LIABILITY UNDER THIS WARRANTY IS LIMITED TO THE REPAIR OR REPLACEMENT PROVIDED ABOVE AND, IN NO EVENT, SHALL THE COMPANY'S LIABILITY EXCEED THE PURCHASE PRICE PAID BY PURCHASER FOR THE PRODUCT.

This Warranty is in lieu of all other express warranties or liabilities. ANY IMPLIED WARRANTIES, INCLUDING ANY IMPLIED WARRANTY OF MERCHANTABILITY, SHALL BE LIMITED TO THE DURATION OF THIS WRITTEN WARRANTY. ANY ACTION FOR BREACH OF ANY WARRANTY HEREUNDER INCLUDING ANY IMPLIED WARRANTY OF MERCHANTABILITY MUST BE BROUGHT WITHIN A PERIOD OF 30 MONTHS FROM DATE OF ORIGINAL PURCHASE. IN NO CASE SHALL THE COMPANY BE LIABLE FOR ANY CONSEQUENTIAL OR INCIDENTAL DAMAGES FOR BREACH OF THIS OR ANY OTHER WARRANTY, EXPRESS OR IMPLIED, WHATSOEVER. No person or representative is authorized to assume for the Company any liability other than expressed herein in connection with the sale of this product.

Some states do not allow limitations on how long an implied warranty lasts or the exclusion or limitation of incidental or consequential damage so the above limitations or exclusions may not apply to you. This Warranty gives you specific legal rights and you may also have other rights which vary from state to state.

**CANADA:** CALL 1-800-645-4994 FOR LOCATION OF WARRANTY STATION SERVING YOUR AREA

128-5556C